

LUND Ventvisor® Deflector

**For proper installation and best possible fit, please read all instructions BEFORE you begin.
For technical assistance or to obtain missing parts, please call Customer Relations at 1-800-241-7219.**

Important Safety Information



- CAUTION - Before driving, ensure that the vent visor is properly secured to vehicle.
- Do not use automatic "brush-style" car washes.
- Do not use cleaning solvents of any kind.
- Periodically check all components for tightness.

Contents - 2 Piece Set **NOTE:** Actual product may vary from illustration.



Front Driver
Side Visor



Front Passenger
Side Visor



Alcohol Pad x2

Contents - 4 Piece Set



Front Driver
Side Visor



Front Passenger
Side Visor

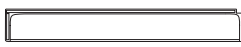

Rear Driver
Side Visor



Rear Passenger
Side Visor



Alcohol Pad x4

Tools Required



Car Wash Supplies



Clean Towel

Preparation Before Painting / Installation

- A trial fit is recommended to ensure proper positioning and fit.
- Check fit of parts before painting as we will not accept the return of modified or painted parts.
- Wash and dry your vehicle to remove any debris and/or dirt from the installation area.

Installation Steps **NOTE:** Actual application may vary slightly from illustrations.



Clean the window channel
with an alcohol pad.

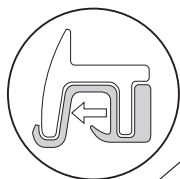

1

Remove tape liner from front flange. Peel back
2" of tape liner from each end of top flange.

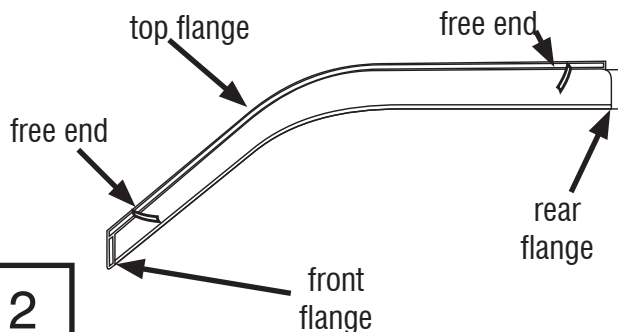

2

Installation Steps

NOTE: Actual application may vary slightly from illustrations.

Insert visor into window channel, rear flange first. Rear flange inserts between the trim and the exterior surface. The front & top flange slides into the window channel.

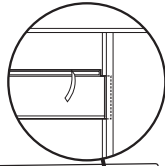

3

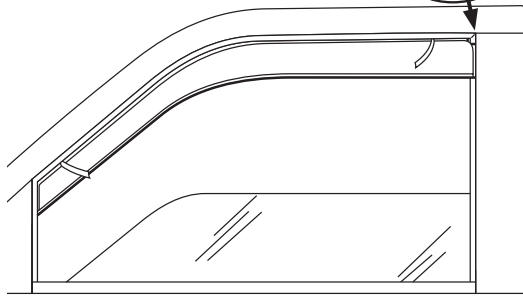

Remove tape liner by pulling on free ends. Raise window slowly and leave up for 24 hours to secure visor to window channel.

4

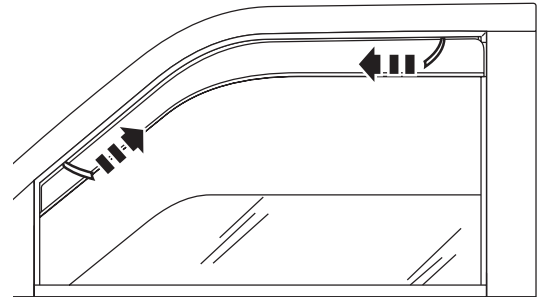

Apply pressure to all flange edges to ensure proper adhesion.

5

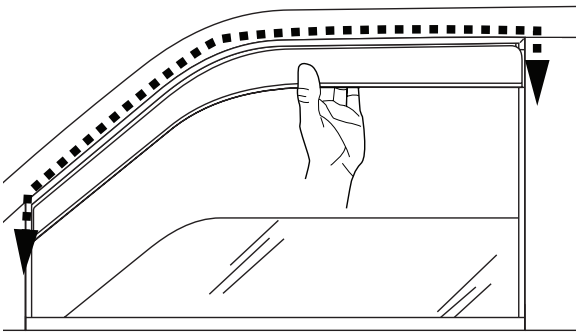

NOTE: It is necessary to both hold the visor up into the window channel **AND** pull the bottom of the visor slightly outward while raising the glass to seat visor properly.

6

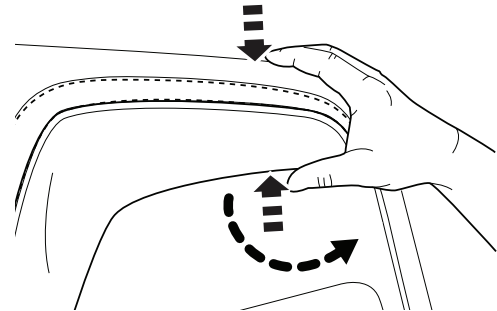

4 Piece Set

Install the rear visor using the same preparation and installation methods as front visor. Note that the top & rear flanges slide into the window channel, and the front flange fits between the rubber & window frame.

7

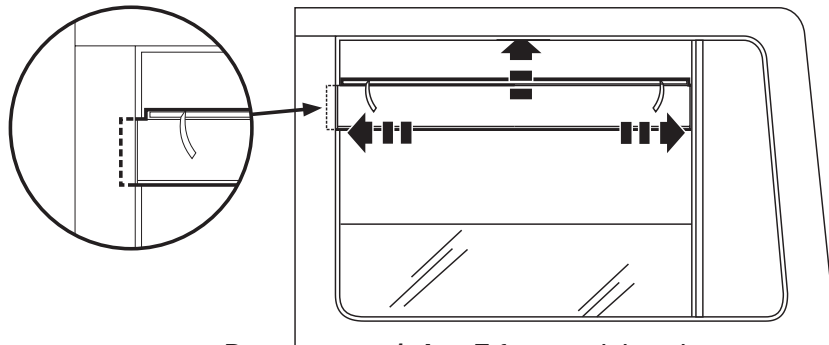

Repeat steps 1 thru 7 for remaining visors

Care and Cleaning

- Wash only with mild soap & dry with a clean cloth.

Congratulations!

You have purchased one of the many quality Lund[®] branded products offered by Lund International, Inc. We take the utmost pride in our products and want you to enjoy years of satisfaction from your investment. We have made every effort to ensure that your product is top quality in terms of fit, durability, finish and ease of installation.

LUND[®]

Lund International

800-241-7219 • Visit us at lundinternational.com

© 2015 Lund International, Inc. All rights reserved.

Lund[®] and the Lund[®] logo are trademarks of Lund International, Inc.



LUND® Ventvisor® Deflector

Pour obtenir une installation correcte et le meilleur ajustement possible, lire toutes les instructions AVANT de commencer.
Pour toute assistance technique ou obtention de pièces manquantes, appeler le service des relations avec la clientèle au 1-800-241-7219.

Informations importantes concernant la sécurité



- ATTENTION – Avant de conduire, s'assurer que la visière est solidement assujettie sur le véhicule.
- Ne pas utiliser les stations de lavage de voitures à brosses.
- Ne pas utiliser de solvants.
- Vérifier régulièrement le serrage des composants.

Contenu - Ensemble 2 pièces

NOTE: Le produit réel peut changer de l'illustration.

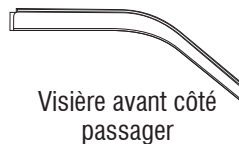

Tampons à l'alcool
(2)

Contenu - Ensemble 4 pièces

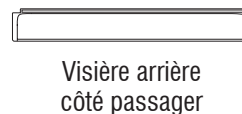
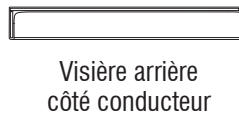

Tampons à l'alcool
(4)

Outils nécessaires



Fournitures pour lavage de voiture



Serviette propre

Préparation pour la peinture/l'installation

- Il est recommandé de procéder à un essai pour s'assurer que le positionnement et l'ajustement sont corrects.
- Vérifier l'ajustement des pièces avant peinture, car nous n'acceptons pas le retour de pièces modifiées ou peintes.
- Laver les glissières de glaces de la portière du véhicule pour éliminer toute poussière et tous débris.
- Sécher les glissières avec une serviette propre.

Étapes d'installation

REMARQUE : La méthode d'application peut être légèrement différente de celle représentée par les illustrations.

Alcohol Pad

Nettoyer la glissière de glace avec un tampon à l'alcool.

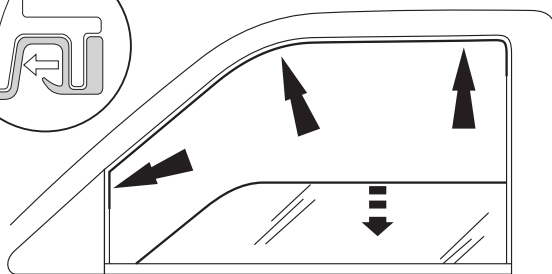
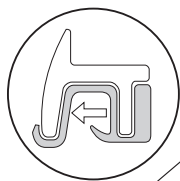

1

Retirer la protection d'adhésif du rebord avant. Décoller 5 cm (2 po) de protection d'adhésif à chaque extrémité du rebord supérieur.

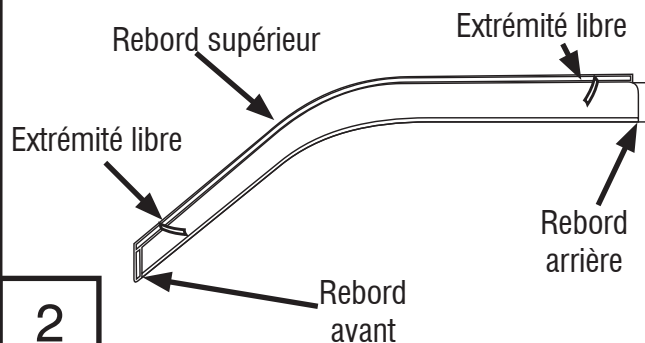

2

Étapes d'installation

REMARQUE : La méthode d'application peut être légèrement différente de celle représentée par les illustrations.

Insérer le rebord arrière de la visière dans la glissière de glace en premier. Le rebord arrière s'insère entre la garniture de glace et la surface extérieure. Les rebords avant et supérieur s'engagent dans la glissière de glace.

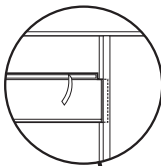

3

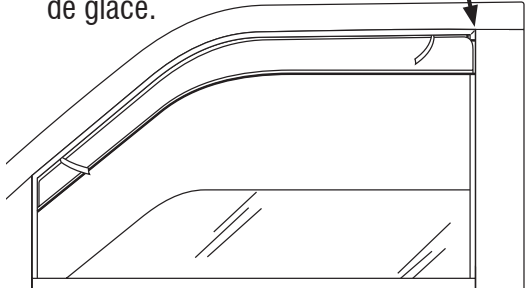

Retirer la protection d'adhésif en tirant sur ses extrémités libres. Relever lentement la glace et la laisser remontée pendant 24 heures afin de permettre à la visière de bien adhérer à la glissière de glace.

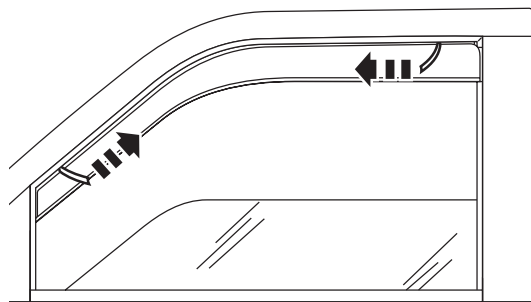

4

Exercez une pression sur tous les bords des brides afin de vous assurer que la pièce colle bien.

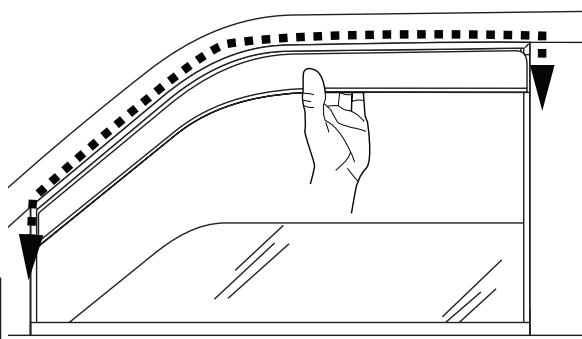

5

NOTE: Il faut à la fois tenir la visière en place dans le canal de la fenêtre et tirer le bas de la visière légèrement vers l'extérieur tout en augmentant le verre à visière siège correctement.

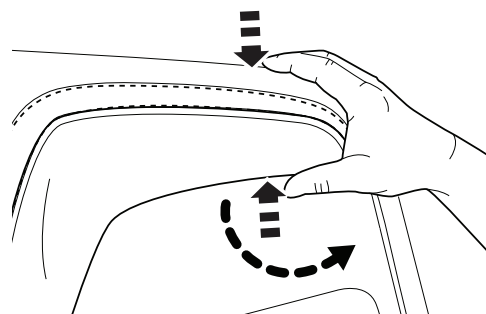

6

Ensemble 4 pièces

Installer la visière arrière en utilisant la même méthode de préparation et d'installation que pour la visière avant. Noter que les rebords supérieur et arrière s'engagent en glissant dans la glissière de la glace, et que le rebord avant s'insère entre le caoutchouc et le cadre de glace.

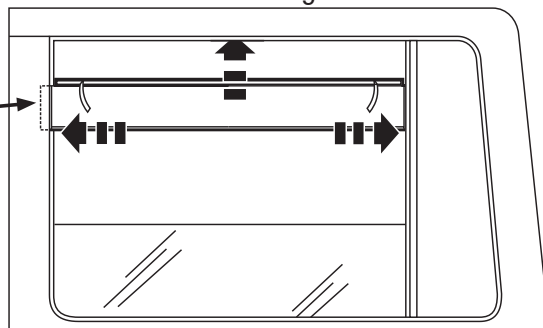
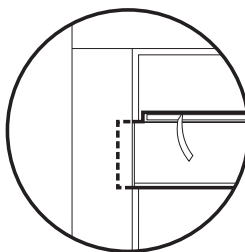

7

Répéter les étapes 1 à 7 pour les visières restantes

Entretien et nettoyage

- Laver exclusivement avec de l'eau savonneuse et sécher avec un chiffon propre.

Félicitations !

Vous venez d'acheter un des nombreux produits de qualité de la marque Lund[®] fabriqués par Lund International, Inc. Nous sommes extrêmement fiers de la qualité de nos produits et nous espérons que vous profiterez de cet investissement de longues années durant. Nous nous efforçons d'offrir la meilleure qualité en termes d'ajustement, de finition, de durabilité et de facilité d'installation.

LUND[®]

Lund International

800-241-7219 • Visitez notre site lundinternational.com

© 2015 Lund International, Inc. Tous droits réservés.

Lund[®] et le logo Lund[®] sont des marques déposées de Lund International, Inc.



LUND Ventvisor® Deflector

Para una instalación adecuada y el mejor ajuste posible, lea todas las instrucciones ANTES de comenzar. Si desea recibir asistencia técnica u obtener piezas faltantes, llame al Servicio al cliente al 1-800-241-7219.

Información importante de seguridad



- PRECAUCIÓN - Antes de conducir, asegúrese de que la visera esté correctamente anclada al vehículo.
- No utilice servicios automáticos de limpieza de vehículos que utilizan cepillos.
- No utilice limpiadores al solvente de ningún tipo.
- Compruebe periódicamente que todos los componentes estén ajustados.

Contenido - Juego de dos piezas

NOTA: El producto real puede variar de la ilustración.



Paños esterilizados x 2

Contenido - Juego de cuatro piezas

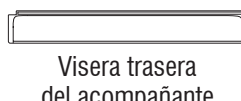
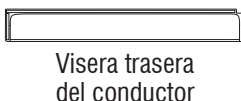

Paños esterilizados x 4

Herramientas necesarias



Equipo de limpieza de vehículos



Toalla limpia

Preparación antes de pintar o instalar

- Se recomienda realizar un ajuste de prueba para asegurar el posicionamiento y ajuste correctos.
- Compruebe que las piezas se ajusten correctamente antes de pintarlas, ya que no aceptaremos la devolución de piezas modificadas o pintadas.
- Lave los canales de la ventanilla del vehículo para quitar los desechos y la suciedad.
- Seque los canales de la ventanilla con una toalla limpia.

Pasos de instalación

AVISO: La colocación real puede variar con respecto a las ilustraciones.

Alcohol Pad

Limpie el canal de la ventanilla con un paño esterilizado.

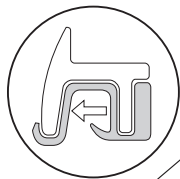

1

Quite la cinta protectora del reborde frontal. Retire 2 pulgs. (5 cm) de cinta protectora de cada uno de los extremos del reborde superior.

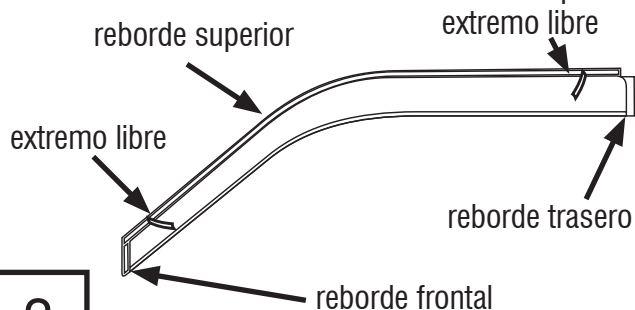

2

Pasos de instalación

AVISO: La colocación real puede variar con respecto a las ilustraciones.

Inserte la visera en el canal de la ventanilla comenzando con el reborde trasero. El reborde trasero se introduce entre la banda lateral y la superficie exterior. El reborde superior frontal se desliza por el canal de la ventanilla.

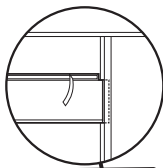

3

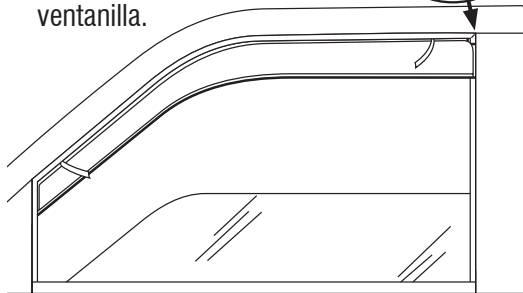

Retire la cinta protectora tirando de los extremos libres. Levante la ventanilla lentamente y déjela en esa posición por 24 horas para que la visera se fije en el canal de la ventanilla.

4

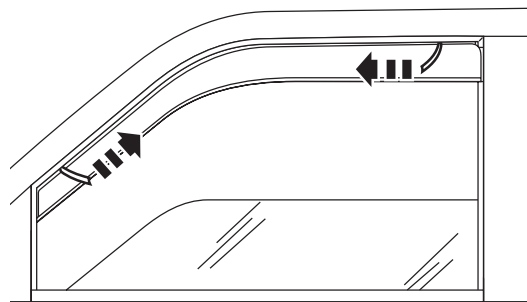

Ejerza presión en todos los bordes del reborde para que se adhiera correctamente.

5

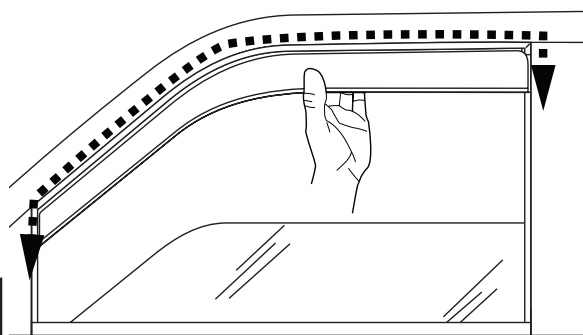

NOTA: Es necesario tanto para mantener la visera hacia arriba en el canal de la ventana y tire de la parte inferior de la visera ligeramente hacia fuera mientras levanta la copa a la visera asiento correctamente.

6

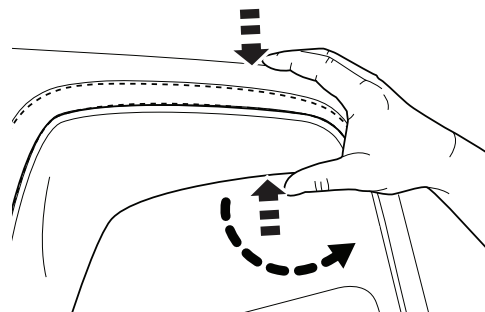

Juego de cuatro piezas

Instale la visera trasera con los mismos métodos de preparación e instalación que utilizó para la visera frontal. Tenga en cuenta que los rebordes superior y trasero se adhieren al canal de la ventanilla y el reborde frontal se inserta entre la goma y el marco de la ventanilla.

7

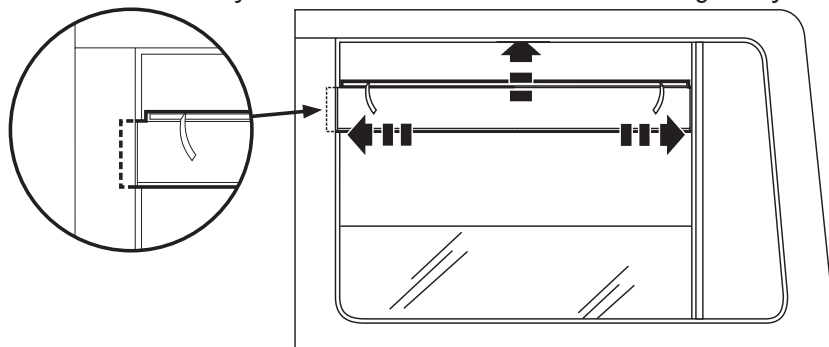

Repita los **pasos 1 a 7** en el lado del pasajero.

Cuidado y limpieza

- Limpie solamente con agua jabonosa tibia y seque con un paño limpio.

Felicidades

Usted ha adquirido uno de los tantos productos de calidad de marca Lund[®] que ofrece Lund International, Inc. Nos enorgullecen mucho nuestros productos y deseamos que disfrute años de satisfacción por su inversión. Nos hemos esforzado mucho para asegurarnos de que su producto sea de gran calidad en cuanto a ajuste, durabilidad, acabado y facilidad de instalación.

LUND[®]

Lund International

800-241-7219 • Visite nuestro sitio Web: lundinternational.com

© 2015 Lund International, Inc. Todos los derechos reservados.

Lund[®] y el logo de Lund[®] son marcas registradas de Lund International, Inc.

